



TABLE OF CONTENTS

1.DATA SHEET

PAGE 1

2.MARKING

PAGE 7

3.TAPING

PAGE 8

4.PACKING

PAGE 9

5.HIGH RELIABILITY TEST SPEC.

PAGE 13



PJA138K

50V N-Channel Enhancement Mode MOSFET – ESD Protected

Voltage 50 V **Current** 500mA

Features

- RDS(ON) , VGS@10V, ID@500mA<1.6Ω
- RDS(ON) , VGS@4.5V, ID@200mA<2.5Ω
- RDS(ON) , VGS@2.5V, ID@100mA<4.5Ω
- Advanced Trench Process Technology
- Specially Designed for Battery Operated Systems, Solid-State Relays Drivers: Relay, Displays, Memories, etc.
- ESD Protected 2KV HBM
- Lead free in compliance with EU RoHS 2011/65/EU directive.
- Green molding compound as per IEC61249 Std.
(Halogen Free)

Mechanical Data

- Case: SOT-23 Package
- Terminals : Solderable per MIL-STD-750, Method 2026
- Approx. Weight: 0.0003 ounces, 0.0084 grams

SOT-23

Unit : inch(mm)

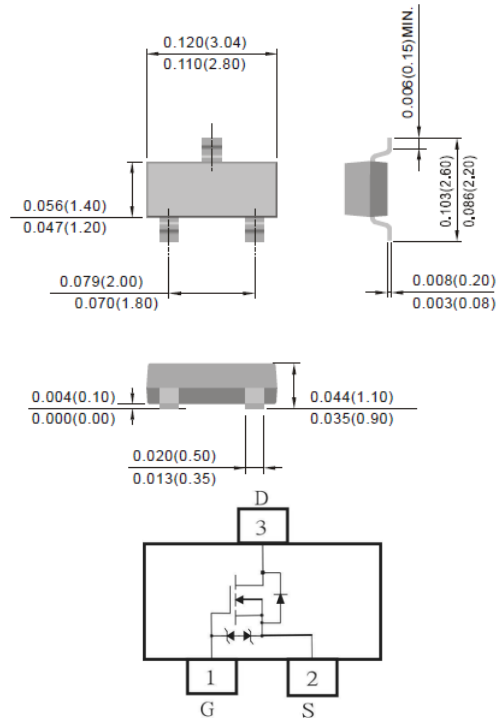

Maximum Ratings and Thermal Characteristics (T_A=25 °C unless otherwise noted)

PARAMETER	SYMBOL	LIMIT	UNITS
Drain-Source Voltage	V _{DS}	50	V
Gate-Source Voltage	V _{GS}	+20	V
Continuous Drain Current	I _D	500	mA
Pulsed Drain Current	I _{DM}	1200	mA
Power Dissipation	P _D	T _A =25°C	500
		Derate above 25°C	4
Operating Junction and Storage Temperature Range	T _J , T _{STG}	-55~150	°C
Typical Thermal resistance	R _{θJA}	250	°C/W
- Junction to Ambient ^(Note 3)			



PJA138K

Electrical Characteristics ($T_A=25^{\circ}\text{C}$ unless otherwise noted)

PARAMETER	SYMBOL	TEST CONDITION	MIN.	TYP.	MAX.	UNITS
Static						
Drain-Source Breakdown Voltage	BV_{DSS}	$V_{GS}=0V, I_D=250\mu A$	50	-	-	V
Gate Threshold Voltage	$V_{GS(th)}$	$V_{DS}=V_{GS}, I_D=250\mu A$	0.8	1.0	1.5	V
Drain-Source On-State Resistance	$R_{DS(on)}$	$V_{GS}=10V, I_D=500mA$	-	0.96	1.6	Ω
		$V_{GS}=4.5V, I_D=200mA$	-	1.25	2.5	
		$V_{GS}=2.5V, I_D=100mA$	-	2.73	4.5	
Zero Gate Voltage Drain Current	I_{DSS}	$V_{DS}=50V, V_{GS}=0V$	-	0.01	1	μA
Gate-Source Leakage Current	I_{GSS}	$V_{GS}=\pm 20V, V_{DS}=0V$	-	± 3.0	± 10	μA
Dynamic						
Total Gate Charge	Q_g	$V_{DS}=25V, I_D=250mA,$ $V_{GS}=4.5V$ (Note 1,2)	-	0.63	1	nC
Gate-Source Charge	Q_{gs}		-	0.2	-	
Gate-Drain Charge	Q_{gd}		-	0.23	-	
Input Capacitance	C_{iss}	$V_{DS}=25V, V_{GS}=0V,$ $f=1.0MHz$	-	25	50	μF
Output Capacitance	C_{oss}		-	9.5	20	
Reverse Transfer Capacitance	C_{rss}		-	2.1	5	
Switching						
Turn-On Delay Time	$t_{d(on)}$	$V_{DD}=25V, I_D=500mA,$ $V_{GS}=10V,$ $R_G=6\Omega$ (Note 1,2)	-	2.2	5	ns
Turn-On Rise Time	t_r		-	19.2	38	
Turn-Off Delay Time	$t_{d(off)}$		-	6.2	12	
Turn-Off Fall Time	t_f		-	23	50	
Drain-Source Diode						
Maximum Continuous Drain-Source Diode Forward Current	I_S	---	-	-	500	mA
Diode Forward Voltage	V_{SD}	$I_S=500mA, V_{GS}=0V$		0.86	1.5	V

NOTES:

1. Pulse width $\leq 300\mu s$, Duty cycle $\leq 2\%$
2. Essentially independent of operating temperature typical characteristics.
3. $R_{\theta JA}$ is the sum of the junction-to-case and case-to-ambient thermal resistance where the case thermal reference is defined as the solder mounting surface of the drain pins. mounted on a 1 inch square pad of copper



PJA138K

TYPICAL CHARACTERISTIC CURVES

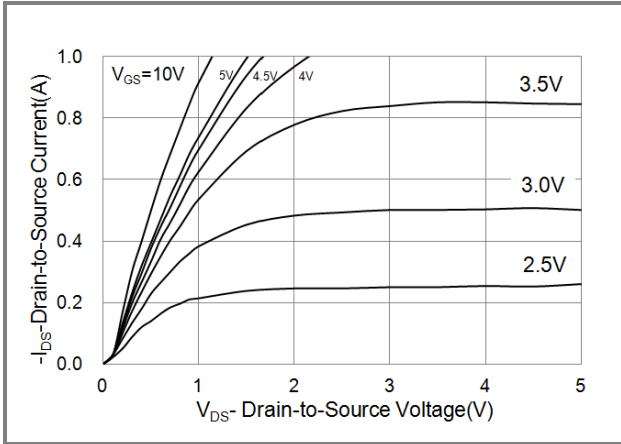

Fig.1 On-Region Characteristics

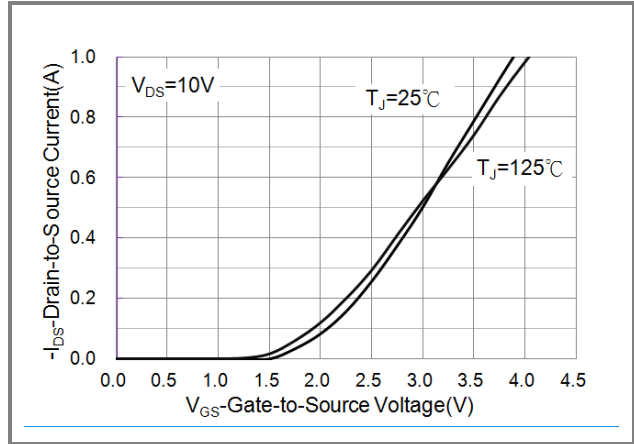

Fig.2 Transfer Characteristics

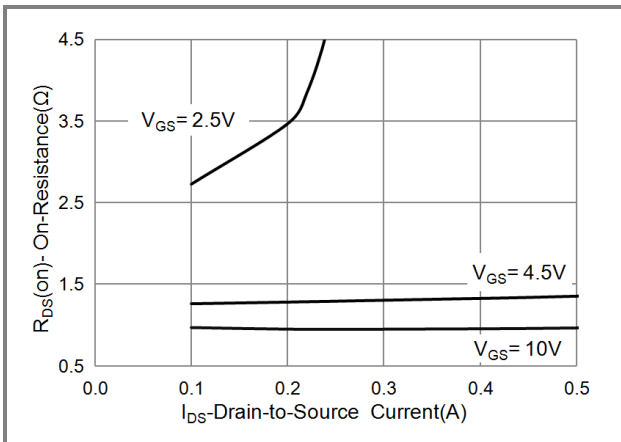

Fig.3 On-Resistance vs. Drain Current

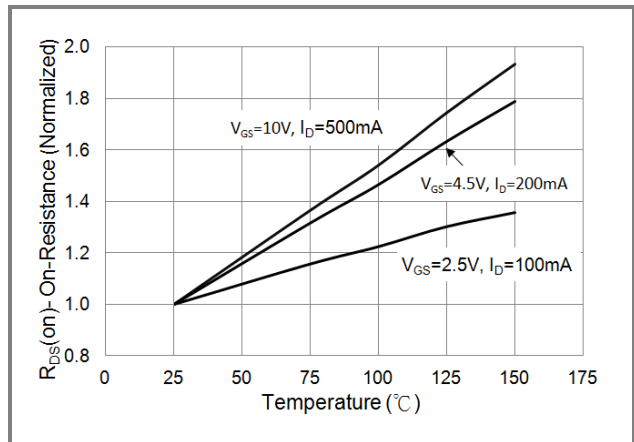

Fig.4 On-Resistance vs. Junction temperature

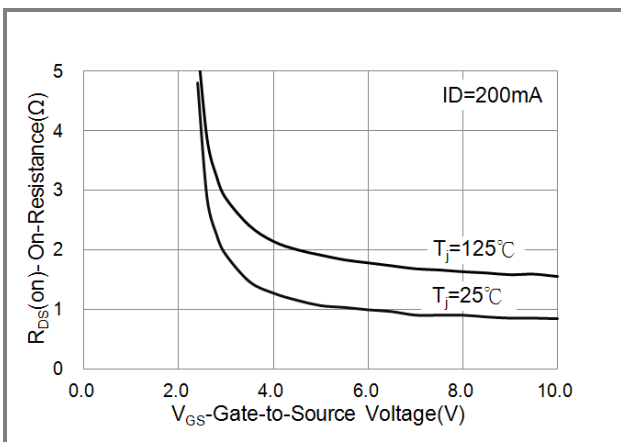

Fig.5 On-Resistance Variation with VGS.

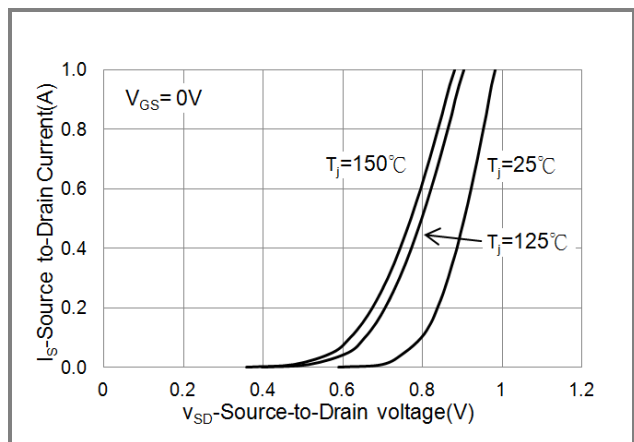

Fig.6 Body Diode Characteristics



PJA138K

TYPICAL CHARACTERISTIC CURVES

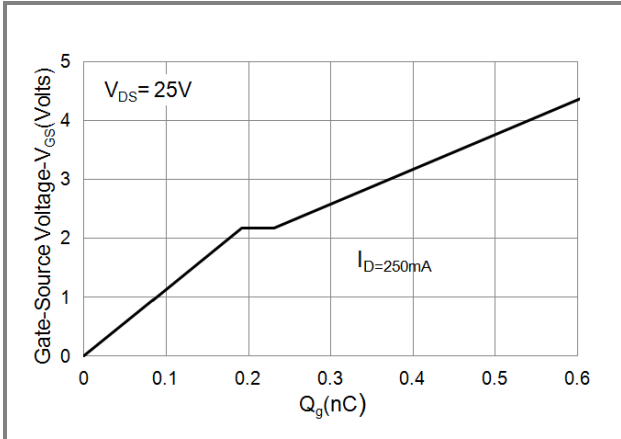

Fig.7 Gate-Charge Characteristics

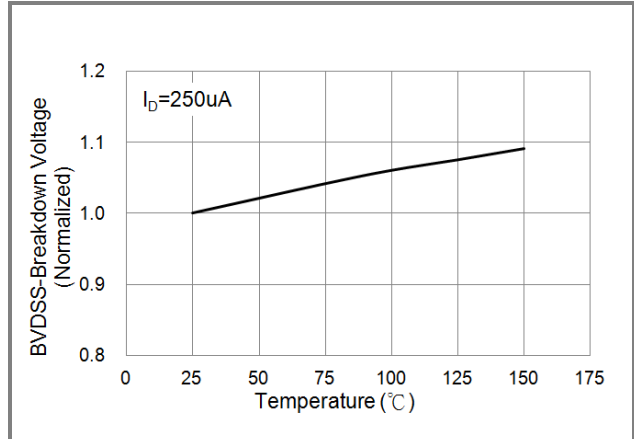

Fig.8 Breakdown Voltage Variation vs. Temperature

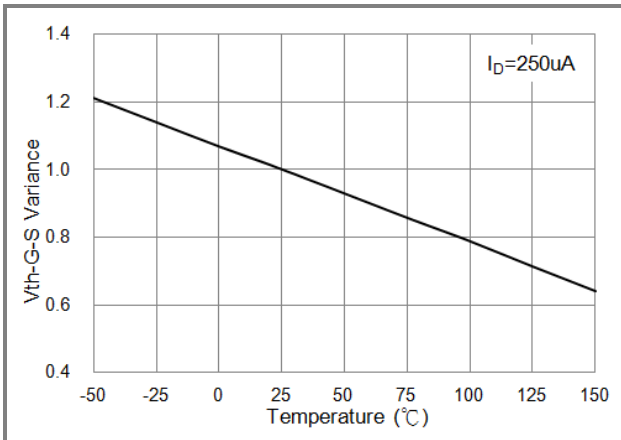

Fig.9 Threshold Voltage Variation with Temperature.

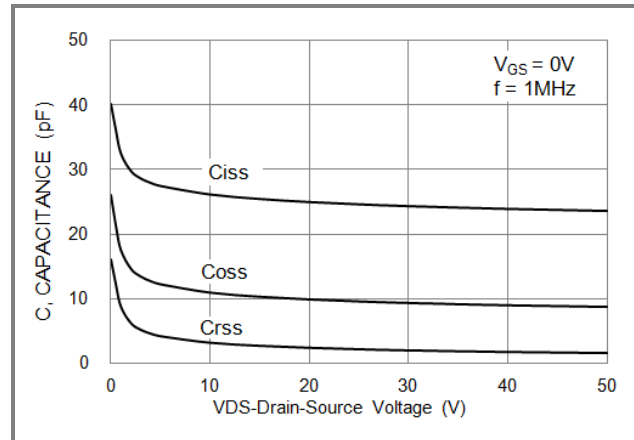

Fig.10 Capacitance vs. Drain-Source Voltage.



PJA138K

PART NO PACKING CODE VERSION

PART NO PACKING CODE VERSION	Package Type	Packing type	Marking	Version
PJA138K_R1_00001	SOT-23	3K pcs / 7" reel	8K3	Halogen free
PJA138K_R2_00001	SOT-23	12K pcs / 13" reel	8K3	Halogen free

MOUNTING PAD LAYOUT

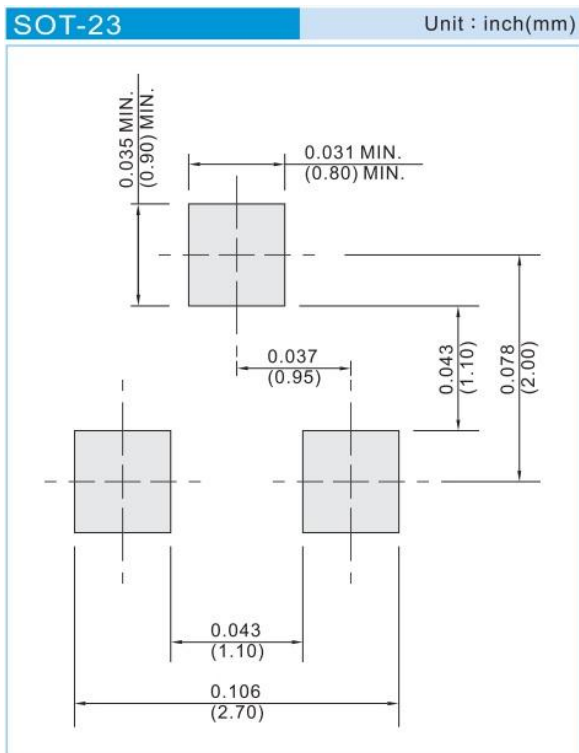



PJA138K

Disclaimer

- Reproducing and modifying information of the document is prohibited without permission from Panjit International Inc..
- Panjit International Inc. reserves the rights to make changes of the content herein the document anytime without notification. Please refer to our website for the latest document.
- Panjit International Inc. disclaims any and all liability arising out of the application or use of any product including damages incidentally and consequentially occurred.
- Panjit International Inc. does not assume any and all implied warranties, including warranties of fitness for particular purpose, non-infringement and merchantability.
- Applications shown on the herein document are examples of standard use and operation. Customers are responsible in comprehending the suitable use in particular applications. Panjit International Inc. makes no representation or warranty that such applications will be suitable for the specified use without further testing or modification.
- The products shown herein are not designed and authorized for equipments requiring high level of reliability or relating to human life and for any applications concerning life-saving or life-sustaining, such as medical instruments, transportation equipment, aerospace machinery et cetera. Customers using or selling these products for use in such applications do so at their own risk and agree to fully indemnify Panjit International Inc. for any damages resulting from such improper use or sale.
- Since Panjit uses lot number as the tracking base, please provide the lot number for tracking when complaining.



2. MARKING

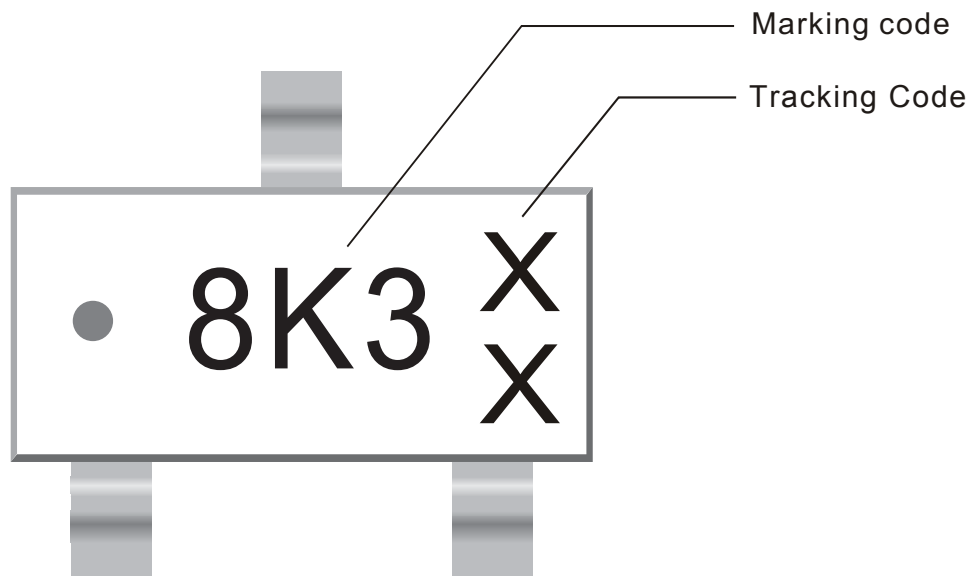



3. TAPING

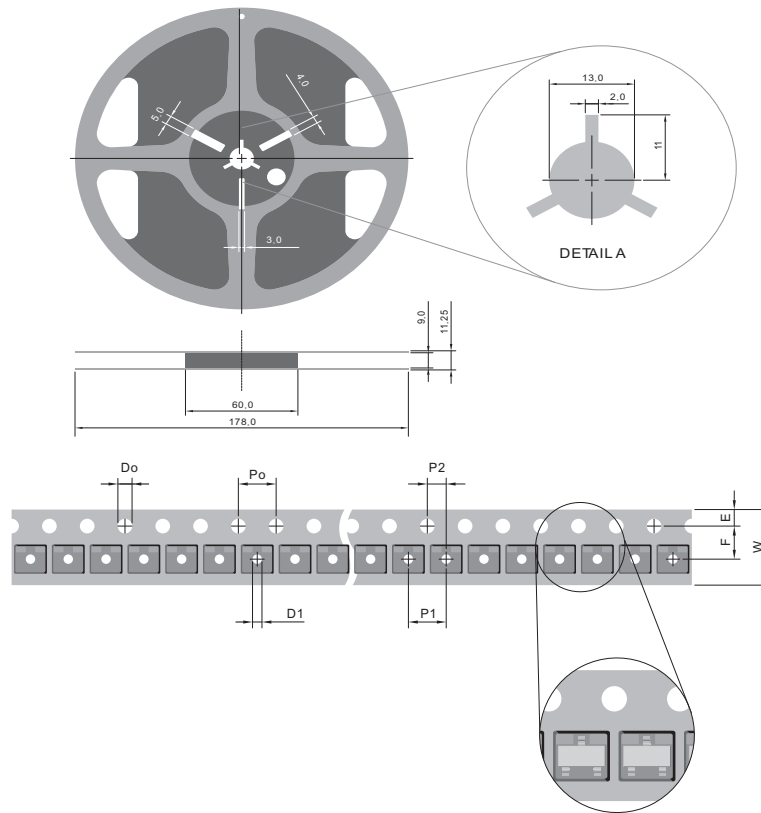

SYMBOL	mm(inch)	
TYPE SIZE	8.00	(0.315)
Do	1.50 + 0.1	(0.059 + 0.004)
Do	1.50 - 0	(0.059 - 0)
Do	1.55 ± 0.05	(0.061 ± 0.002)
D1	1.00 + 0.25	(0.040 + 0.001)
D1	1.00 - 0.10	(0.040 - 0.004)
E	1.75 ± 0.10	(0.069 ± 0.004)
F	3.50 ± 0.05	(0.137 ± 0.002)
Po	4.00 ± 0.10	(0.157 ± 0.004)
P1	4.00 ± 0.10	(0.157 ± 0.004)
P2	2.00 ± 0.05	(0.079 ± 0.002)
W	8.00 + 0.30	(0.315 + 0.012)
W	8.00 - 0.15	(0.315 - 0.006)

NOTE:

1. There shall be leader of 230 mm minimum which may consist of carrier and or cover tape follower by a minimum of 160 mm of carrier tape sealed with cover tape.
2. There shall be minimum of 160 mm of empty component pockets sealed with cover tape.
3. Devices are packed in accordance with EIA standard EIA-481-A and specifications given above.



4. PACKING

REEL PACKING

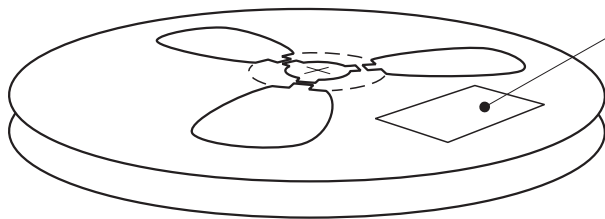

Quantity per Reel: 3,000 pcs

LABEL TYPE

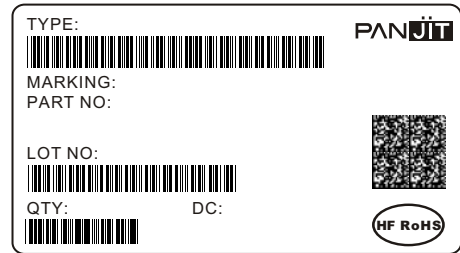

CARTON

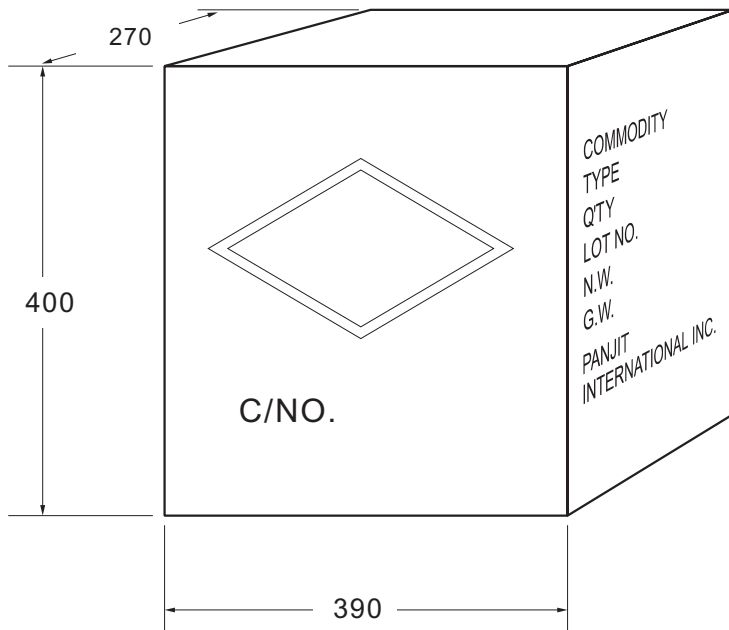

Box Dimensions : mm
Quantity per Box: 240,000pcs

SHIPPING MARK

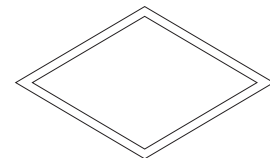

C/NO.
PRODUCT COUNTRY

SIDE MARK

COMMODITY:
TYPE:
Q'TY:
LOT NO.
N.W.
G.W.
PANJIT
INTERNATIONAL INC.



Packing Specifications

Package	Reel Size	Reel	Component Space	Tape Space	Reel Dia	Carton Size	Carton	Approx. Gross Weight
	(inch)	(pcs)	(mm)	(mm)	(mm)	(mm)	(EA)	(kg)
Reel Packing								
DFN0603	7	10,000	2	8	178	390 x 270 x 400	800,000	9
DFN 2L	7	8,000	2	8	178	390 x 270 x 400	640,000	8.6
DFN 3L	7	8,000	2	8	178	390 x 270 x 400	640,000	8.6
	13	12,000	4	8	330	375 x 360 x 230	144,000	7.6
DFN2510-10L	7	5,000	4	8	178	390 x 270 x 400	400,000	10.5
	13	12,000	4	8	330	375 x 360 x 230	144,000	6.4
DFN2020-6L	7	3,000	4	8	178	390 x 270 x 400	240,000	10.1
DFN2020B-6L(ESD)	7	3,000	4	8	178	455 x 270 x 440	240,000	12.3
DFN2020-8L	7	3,000	4	8	178	390 x 270 x 400	240,000	10.1
DFN3030-8L	7	5,000	8	12	330	375 x 360 x 422	70,000	7.3
DFN5060-8L	13	3,000	8	12	330	375 x 360 x 422	42,000	8.5
SC-59(ESD)	7	3,000	4	8	178	455 x 270 x 440	240,000	9.9
SOP-8	13	2,500	8	12	330	375 x 360 x 230	20,000	5.7
SOD-923	7	8,000	2	8	178	390 x 270 x 400	640,000	7.7
SOD-523	7	5,000	4	8	178	390 x 270 x 400	400,000	9.1
	13	12,000	4	8	330	375 x 360 x 230	144,000	5.4
SOD-323HE	7	5,000	4	8	178	390 x 270 x 400	400,000	11.9
	13	12,000	4	8	178	375 x 360 x 230	144,000	8.3
SOD-323	7	5,000	4	8	178	390 x 270 x 400	400,000	9.4
	13	12,000	4	8	330	375 x 360 x 230	144,000	5.9
SOD-123HE	7	3,000	4	8	178	390 x 270 x 400	240,000	12.4
	13	10,000	4	8	330	375 x 360 x 230	120,000	8.1
SOD-123FL	7	3,000	4	8	178	390 x 270 x 400	240,000	10.6
	13	10,000	4	8	330	375 x 360 x 230	120,000	7.2
SOD-123	7	3,000	4	8	178	390 x 270 x 400	240,000	9.9
	13	10,000	4	8	330	375 x 360 x 230	120,000	6.5
SOT-723	7	8,000	2	8	178	455 x 270 x 440	640,000	10.5
SOT-563	7	8,000	2	8	178	390 x 270 x 400	640,000	9.4
	13	20,000	2	8	330	375 x 360 x 230	240,000	5.2
SOT-553	7	4,000	4	8	178	390 x 270 x 400	320,000	9.4
	13	10,000	4	8	330	375 x 360 x 230	120,000	5.2
SOT-543	7	4,000	4	8	178	390 x 270 x 400	320,000	9.4
	13	10,000	4	8	330	375 x 360 x 230	120,000	5.2
SOT-523	7	4,000	4	8	178	390 x 270 x 400	320,000	10
SOT-363	7	3,000	4	8	178	390 x 270 x 400	240,000	9.3
	13	10,000	4	8	330	375 x 360 x 230	120,000	7.1
SOT-353	7	3,000	4	8	178	390 x 270 x 400	240,000	10
	13	10,000	4	8	330	375 x 360 x 230	120,000	7.2
SOT-23 6L	7	3,000	4	8	178	390 x 270 x 400	240,000	14.5
	13	10,000	4	8	330	375 x 360 x 230	120,000	7.9
SOT-23 6L-1	7	3,000	4	8	178	390 x 270 x 400	240,000	14.5
	13	10,000	4	8	330	375 x 360 x 230	120,000	7.9
SOT-23 5L	7	3,000	4	8	178	390 x 270 x 400	240,000	14.5
	13	10,000	4	8	330	375 x 360 x 230	120,000	7.9
SOT-323	7	3,000	4	8	178	390 x 270 x 400	240,000	7.9
	13	12,000	4	8	330	375 x 360 x 230	144,000	6.1
SOT-23-1	7	3,000	4	8	178	390 x 270 x 400	240,000	9.8
	13	12,000	4	8	330	375 x 360 x 230	144,000	7
SOT-23	7	3,000	4	8	178	390 x 270 x 400	240,000	9.8
	13	12,000	4	8	330	375 x 360 x 230	144,000	7
SOT-223	13	2,500	4	8	330	375 x 360 x 422	35,000	13.2
SOT-89(ESD)	7	1,000	4	8	178	455 x 270 x 440	80,000	15.6



Packing Specifications

Package	Reel Size	Reel	Component Space	Tape Space	Reel Dia	Carton Size	Carton	Approx. Gross Weight
	(inch)	(pcs)	(mm)	(mm)	(mm)	(mm)	(EA)	(kg)
Reel Packing								
SMAF	7	3,000	4	12	178	390 x 240 x 420	120,000	10.9
	13	10,000	4	12	330	375 x 360 x 422	160,000	17.1
SMBF	7	1,500	8	12	178	390 x 240 x 420	60,000	9.6
	13	5,000	8	12	330	375 x 360 x 422	80,000	15.6
SMA(W)	7	1,800	4	12	178	390 x 240 x 420	100,800	13
	13	7,500	4	12	330	355 x 355 x 400	150,000	20.4
SMA/DO-214AC	7	1,800	4	12	178	390 x 240 x 420	72,000	10
	13	7,500	4	12	330	375 x 360 x 390	120,000	17.4
SMB/DO-214AA	7	500	8	12	178	390 x 240 x 420	20,000	6.5
	13	3,000	8	12	330	375 x 360 x 390	48,000	13.2
SMC/DO-214AB	7	500	8	16	178	390 x 240 x 420	15,000	8.4
	13	3,000	8	16	330	375 x 360 x 390	42,000	18
R-1	13	5,000	5	52	330	340 x 340 x 410	25,000	7.8
A-405	13	5,000	5	52	330	340 x 340 x 410	25,000	7.79
DO-41	13	5,000	5	52	330	340 x 340 x 410	25,000	11.1
DO-15	13	4,000	5	52	330	340 x 340 x 410	20,000	11.4
DO-201AD	13	1,250	10	52	330	340 x 340 x 410	6,250	9.2
DO-201AE	13	1,250	10	52	330	340 x 340 x 410	6,250	9.2
P-600	13	800	10	52	330	340 x 340 x 410	4,000	9.9
DO-34	15	10,000	5	52	360	360 x 360 x 395	50,000	10.1
DO-35	15	10,000	5	52	360	360 x 360 x 395	50,000	11.2
DO-41G	15	5,000	5	52	360	360 x 360 x 395	25,000	10.9
MICRO-MELF	7	2,500	4	-	178	385 x 380 x 260	200,000	9.3
	13	10,000	4	-	330	360 x 360 x 395	200,000	11.5
QUADRO-MELF	7	2,500	4	-	178	385 x 380 x 260	200,000	13.3
	13	10,000	4	-	330	360 x 360 x 395	200,000	14.9
MINI-MELF/LL-34	7	2,500	4	-	178	385 x 380 x 260	200,000	12.7
	13	10,000	4	-	330	360 x 360 x 395	200,000	14.6
MELF/DL-41	7	1,500	4	-	178	385 x 380 x 260	84,000	18.3
	13	5,000	4	-	330	360 x 360 x 395	100,000	23.5
MDI	13	3,000	8	12	330	375 x 360 x 390	48,000	14.7
MICRO DIP/TDI/LTDI	7	1,000	8	12	178	390 x 240 x 420	40,000	9.5
	13	4,000	8	12	330	375 x 360 x 422	64,000	17
SDIP	13	1,500	12	16	330	375 x 360 x 390	21,000	14.3
TO-277	13	5,000	8	12	330	375 x 360 x 422	80,000	20.6
TO-277B	13	5,000	8	16	330	375 x 360 x 390	80,000	21.8
TO-252	13	3,000	8	16	330	375 x 360 x 422	42,000	18.8
TO-252AA	13	3,000	8	16	330	375 x 360 x 422	42,000	18.8
TO-263/D ² PAK	13	800	16	24	330	375 x 360 x 422	6,400	14.5



Packing Specifications

Package	Inner Box Size	Box	Carton Size	Carton	Approx. Gross Weight
	(mm)	(EA)	(mm)	(EA)	(kg)
Bulk Packing					
R-1	198 x 84 x 20	1,000	459 x 214 x 256	50,000	12.7
A-405	198 x 84 x 20	1,000	459 x 214 x 256	50,000	12.7
DO-41	198 x 84 x 20	1,000	459 x 214 x 256	50,000	19.3
DO-15	200 x 85 x 25	1,000	459 x 214 x 256	40,000	20.7
DO-201AD	200 x 85 x 40	500	459 x 214 x 256	12,500	16
DO-201AE	200 x 85 x 40	500	459 x 214 x 256	12,500	16
P-600	208 x 82 x 40	100	459 x 214 x 256	2,500	11.3
DO-34	240 x 100 x 90	2,000	406 x 335 x 257	120,000	14.5
DO-35	240 x 100 x 90	2,000	406 x 335 x 257	120,000	17.1
DO-41G	240 x 100 x 90	1,000	406 x 335 x 257	60,000	18.5
TO-220AC	540 x 145 x 85	2,000	555 x 306 x 200	8,000	22.9
ITO-220AC	540 x 145 x 85	2,000	555 x 306 x 200	8,000	20.5
TO-220AB	540 x 145 x 85	2,000	555 x 306 x 200	8,000	22.9
ITO-220AB	540 x 145 x 85	2,000	555 x 306 x 200	8,000	20.5
ITO-220AB-F	540 x 145 x 85	2,000	555 x 306 x 200	8,000	20.5
TO-251AA	555 x 145 x 95	8,000	580 x 310 x 220	32,000	18.6
TO-251AB	555 x 145 x 95	8,000	580 x 310 x 220	32,000	18.6
TO-92	188 x 188 x 67	5,000	390 x 420 x 240	50,000	13
TO-3PN	-	-	600 x 185 x 230	1,800	16.4
TO-3PL	-	-	530 x 255 x 110	1,500	12.2
TO-3P/TO-247AD	-	-	530 x 243 x 100	1,500	13.9
TO-3PS/TO-247S	-	-	511 x 243 x 107	1,500	12.2
DIP	-	-	459 x 214 x 256	12,000	6.5
SDIP	-	-	459 x 214 x 256	24,000	15.7

Package	Inner Box Size	Ammo	Component Space	Tape Space	Carton Size	Carton	Approx. Gross Weight
	(mm)	(pcs)	(mm)	(mm)	(mm)	(EA)	(kg)
Ammunition Packing							
R-1	255 x 47 x 73	3,000	5	26	310 x 268 x 170	36,000	6.3
	255 x 73 x 73	3,000	5	52	310 x 268 x 170	24,000	6.3
	255 x 73 x 122	5,000	5	52	339 x 276 x 274	40,000	10.3
A-405	255 x 47 x 150	5,000	5	26	339 x 276 x 330	60,000	12.4
	255 x 75 x 150	5,000	5	52	339 x 276 x 330	40,000	16
DO-41	255 x 75 x 150	5,000	5	52	339 x 276 x 330	40,000	15.9
	255 x 73 x 90	3,000	5	52	333 x 281 x 218	24,000	8.9
DO-15	255 x 75 x 150	3,000	5	52	339 x 276 x 330	24,000	13.3
DO-201AD	255 x 47 x 122	1,250	10	52	339 x 276 x 330	10,000	13.4
DO-201AE	255 x 47 x 122	1,250	10	52	339 x 276 x 330	10,000	13.4
P-600	255 x 47 x 122	400	10	52	339 x 276 x 330	3,200	8.1
DO-34	248 x 80 x 48	5,000	5	26	406 x 335 x 257	150,000	14.5
	248 x 80 x 75	5,000	5	52	406 x 335 x 257	100,000	12.7
DO-35	248 x 80 x 48	5,000	5	26	406 x 335 x 257	150,000	16.7
	248 x 80 x 75	5,000	5	52	406 x 335 x 257	100,000	15.2
DO-41G	248 x 80 x 48	2,500	5	26	406 x 335 x 257	75,000	17.1
	248 x 80 x 75	2,500	5	52	406 x 335 x 257	50,000	15.6
DO-9	265 x 238 x 38	6	-	-	455 x 270 x 440	60	18.9

5.HIGH RELIABILITY TEST SPEC (MOSFET、TRANSISTORS)

Date : 2010.07.05 rev.01

NO.	TEST ITEM	TEST CONDITION	REFERENCED DOCUMENT	LOT QUALITY LEVEL
1	TEMPERATURE CYCLING (T.C.T) 溫度循環試驗	Ta = -55+0°C / -10°C 10min(Min) Ta = +150+15°C / -0°C 10min(Min) FOR 20CYCLES	MIL-STD-750D METHOD-1051.5 Condition G	LTPD 10 S.S=22 ACCEPT FOR 0 FAILURE ONLY.
2	HIGH TEMPERATURE STORAGE LIFE (H.T.S.L) 高溫儲存壽命試驗	Ta=Storage Temperature Range (device specified maximum temperature)	MIL-STD-750D METHOD-1032.2	LTPD 10 S.S = 22 ACCEPT FOR 0 FAILURE ONLY.
3	SOLDERABILITY TEST 錫錫性試驗	Temperature of Solder TEMPERATURE OF SOLDER POT=245 +/- 5°C TIME FOR DIPPING IN SOLDER=5 +/- 0.5 SEC DIPPING DEPTH=0.05inch max from the body FOR ONE CYCLE	MIL-STD-750D METHOD-2026.10	LTPD 7 S.S=32 ACCEPT FOR 0 FAILURE ONLY.
4	HIGH TEMPERATURE REVERSE BIAS (H.T.R.B) 高溫逆向偏壓	Tj ≤ Tj max VR=0.8VR(CUSTOMER SPEC.) DC supply	MIL-STD-750D METHOD-1038.3	LTPD 10 S.S=22 ACCEPT FOR 0 FAILURE ONLY.
5	THERMAL SHOCK (T.S.T) 冷熱衝擊試驗	HOT TANK Ta=100+10/-2°C t= 5min COLD TANK Ta=0+2/-10°C t= 5min 15 CYCLES TIME BETWEEN TRANSFERRING DO NOT EXCEED 10 SEC	MIL-STD-750D METHOD 1056.7	LTPD 10 S.S=22 ACCEPT FOR 0 FAILURE ONLY.
6	PRESSURE COOKER (P.C.T) 壓力鍋試驗	Ta=121°C P=29.7psia / 205kPa or 2.088kg/cm ² Relative Humidity = 100%	JEDEC JESD22-A102-C	LTPD 10 S.S=22 ACCEPT FOR 0 FAILURE ONLY.
7	HUMIDITY 恆溫濕試驗	Ta=85+/-2°C RH=85+/-5%	EIAJ ED-4701 METHOD 103	LTPD 10 S.S=22 ACCEPT FOR 0 FAILURE ONLY.
8	SOLDER RESISTANCE 錫錫耐熱性試驗	TEMPERATURE OF SOLDER POT=260 +/- 5°C TIME FOR DIPPING IN SOLDER=10 + 2 / - 0 SEC DIPPING DEPTH=1.57 +/- 0.79mm FROM THE BODY FOR ONE CYCLE	MIL-STD-750D METHOD 2031.2	LTPD 10 S.S=22 ACCEPT FOR 0 FAILURE ONLY.

APPROVE SHEET ISSUE DATE : 11/13/2015

PAGE . 13